

Tool Changers and Adaptors - Automatic Tool Changers

RQC/RTP - Module Usage Illustrations

RQC-400 Robot Adaptor Module with Optional Modules (Robot Side)

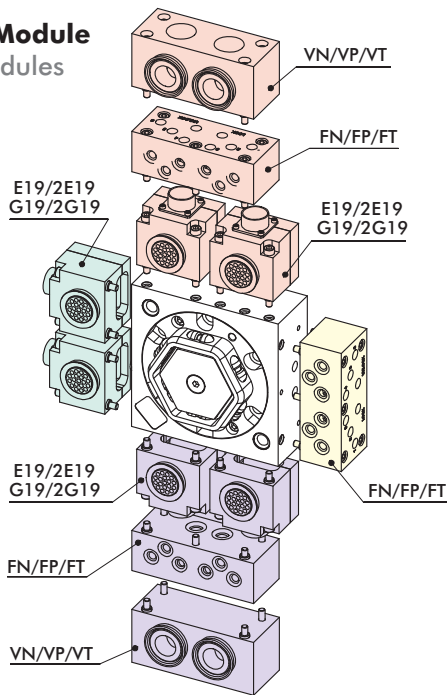

USER PLUG NOT SHOWN

RTP-400 Tool Adaptor Module with Optional Modules (Tool Side)

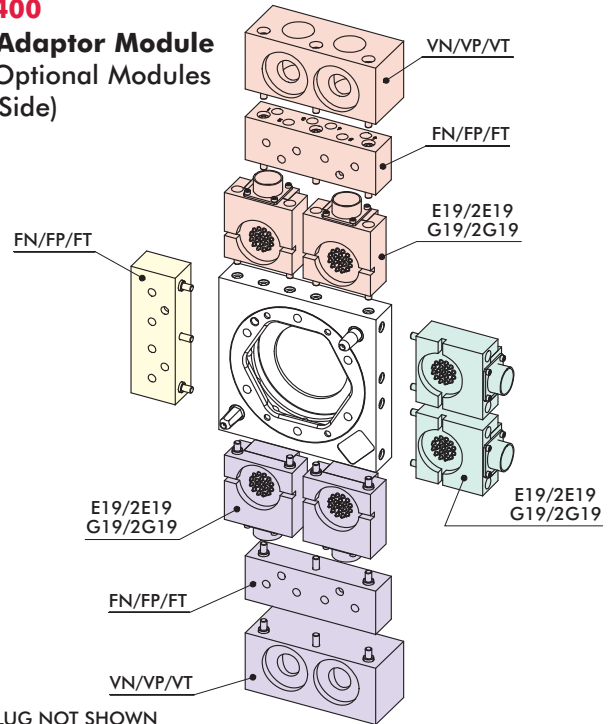

USER PLUG NOT SHOWN

RQC-800/RTP-1200 Robot Adaptor Module with Optional Modules (Robot Side)

Robot Adaptor

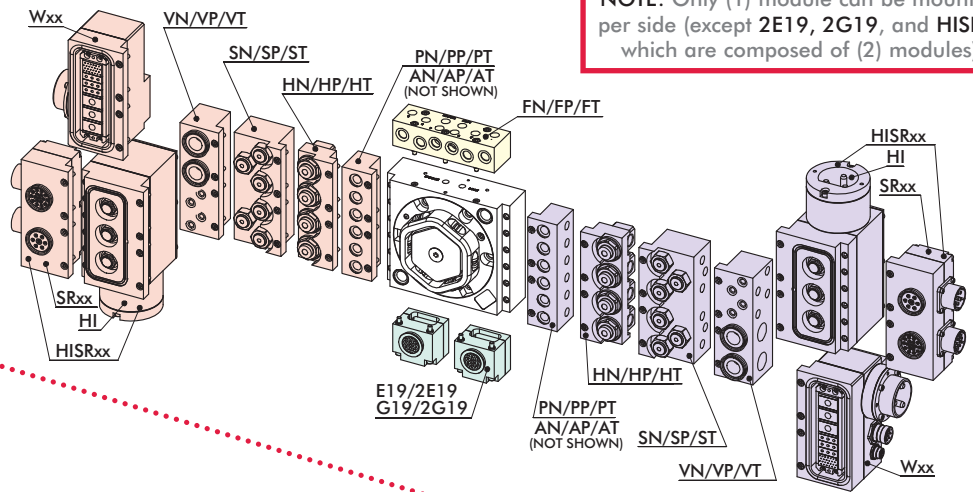

NOTE: Only (1) module can be mounted per side (except 2E19, 2G19, and HISRxx which are composed of (2) modules)

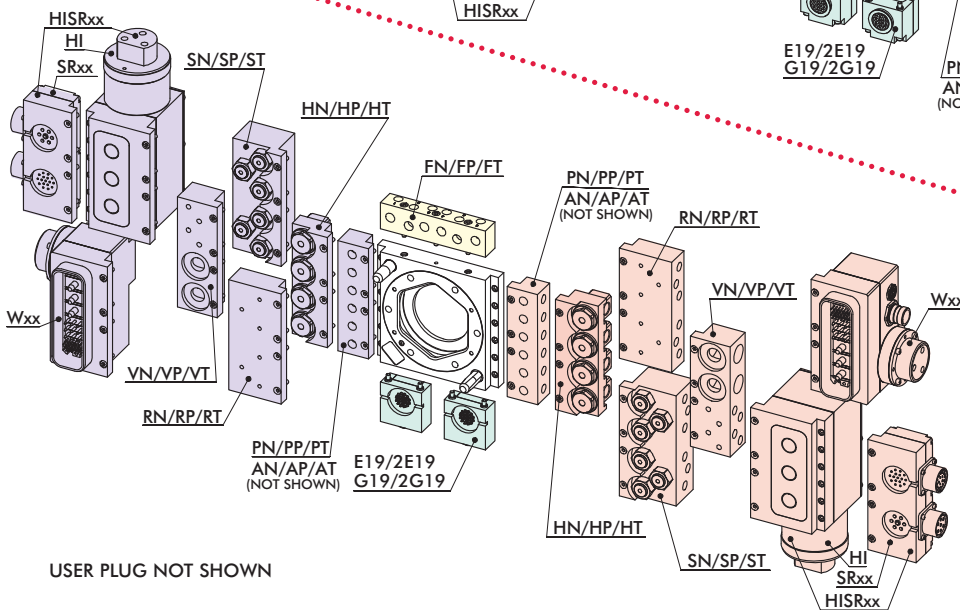

USER PLUG NOT SHOWN

RTP-800/RTP-1200 Tool Adaptor Module with Optional Modules (Tool Side)

Tool Adaptor

USER PLUG NOT SHOWN



Tool Changers and Adaptors - Automatic Tool Changers
RQC/RTP - Configured Tool Changer - Order Information

Base Model	Model Size	Port Options	Sensing (RQC-only)	Side "A" MODULES	Side "B" MODULES	Side "C" MODULES	Side "D" MODULES
RQC	400	N	LO	0	0	0	0
"RQC" Robot Side Adaptor Module	"400" 180 kg [400 lb] Max. Payload	"N" NPT Port	"LO" No Sensing				
"RTP" Tool Side Adaptor Module	"800" 360 kg [800 lb] Max. Payload	"M" BSPP Port	"LP-" PNP Inductive Sensing				
	"1200" 550 kg [1200 lb] Max. Payload	"A" BSPT Port	"CP-" PNP Inductive Sensing with M12 connector				
			"LN-" NPN Inductive Sensing				
			"CN-" NPN Inductive Sensing with M12 connector				
			"LD-" Dry contact sensor				
			"CD-" Dry contact sensor with M12 connector				
			(*) Requires E19 module or G19 module mounted on side C.				
			(†) Cordset or plug are sold separately.				

Optional Air, Vacuum and Electrical Module can be order with Base Model.
 See below for Module Description
 (See Page 6 for Illustrated Module Use Configuration)

NOTE:
 Only (1) module can be mounted per side. (Except 2E19, 2G19, and HISRxx which are composed of (2) modules)

Modules usage is based on the size of the Base Model and which side the Module is can be Mounted. (See page 6)

Module Code	Description	Notes
SIDE "A" Optional Modules		
"0"	No Optional Module	
"FN"	6 X 1/4" NPT Air Ports Module, Face Seal, 10 Bar	
"FP"	6 X 1/4" BSPP Air Ports Module, Face Seal, 10 Bar	
"FT"	6 X 1/4" BSPT Air Ports Module, Face Seal, 10 Bar	
SIDE "B" AND/OR SIDE "D"		
"0"	No optional module	
"FN"	6 X 1/8" NPT Air Ports Module, Face Seal, 10 Bar	RTP/RQC 400 only (Mounted on Side A, Side B and Side D)
"FP"	6 X 1/8" BSPP Air Ports Module, Face Seal, 10 Bar	
"FT"	6 X 1/8" BSPT Air Ports Module, Face Seal, 10 Bar	
"PN"	6 X 1/4" NPT Air Ports Module, Face Seal, 10 Bar	
"PP"	6 X 1/4" BSPP Air Ports Module, Face Seal, 10 Bar	
"PT"	6 X 1/4" BSPT Air Ports Module, Face Seal, 10 Bar	
"AN"	4 X 1/4" "ARV" NPT Air Ports Module, Face Seal, 10 Bar	
"AP"	4 X 1/4" "ARV" BSPP Air Ports Module, Face Seal, 10 Bar	
"AT"	4 X 1/4" "ARV" BSPT Air Ports Module, Face Seal, 10 Bar	
"HN"	4 X 3/8" NPT Fluid Ports Module, 100 Bar	
"HP"	4 X 3/8" BSPP Fluid Ports Module, 100 Bar	
"HT"	4 X 3/8" BSPT Fluid Ports Module, 100 Bar	
"SN"	6 X 1/4" NPT Air Ports Module, Self Sealing, 10 Bar	
"SP"	6 X 1/4" BSPP Air Ports Module, Self Sealing, 10 Bar	
"ST"	6 X 1/4" BSPT Air Ports Module, Self Sealing, 10 Bar	
"VN"	2 X 3/4" Vacuum + 4 X 1/4" Air NPT Ports Module, Face Sealing	RTP/RQC 400 Modules has no "Air Ports"
"VP"	2 X 3/4" Vacuum + 4 X 1/4" Air BSPP Ports Module, Face Sealing	
"VT"	2 X 3/4" Vacuum + 4 X 1/4" Air BSPT Ports Module, Face Sealing	
"Wxx**"	Servo Gun and Welding Gun Module (Pin And Socket)	
"HI"	Welding Gun Module (3 X 180 Amp Spring Loaded Pins)	
"SRxx**"	Servo Gun Module (with Spring Loaded Pins)	
"HISRxx**††"	Servo Gun and Welding Gun Module (with Spring Loaded Pins)	
(**) XX are attributed according to the customer wiring diagram. Consult factory. (††) SRXX Module can be mounted on the HI module to use with electric welding gun.		
SIDE "C"		
"0"	No optional module	
"E19†"	19 pin, 3 Amp, 48 VDC Module w/Turck M12 connector, w/o Cordset	
"2E19†***"	2x 19 pin, 3 Amp, 48 VDC Module w/Turck M12 connector, w/o Cordset	
"G19"	19 pin, 5 Amp, 120 VDC Module w/Industrial User Conn., w/o Cable	
"2G19***"	2x 19 pin, 5 Amp, 120 VDC Module w/Industrial User Conn., w/o Cable	
(†) Cordset or plug are sold separately. (***)Not compatible with CD, CP or CN sensing option.		

Electrical and pneumatic accessories are ordered separately.

Please note some electrical accessories can only be used with certain modules for either RQC or RTP "Base Models".

For pneumatic accessories, size of "Base Model" is considered.

ELECTRICAL ACCESSORIES

- "ELCT-048" 90° Female Plug, w/o Cable, Solder Type, Cable Clamp for G19 (RQC Only)
- "ELCT-049" 90° male Plug, w/o Cable, Solder Type, Cable Clamp for G19 (RTP Only)
- "CABL-028" 90° Female M12 Cordset with 2M Cable for CP, CN, and CD (RQC Only)
- "CABL-029" 90° Female Cordset with 4M Cable for E19 (RQC Only)
- "CABL-031" 90° male Cordset with 2M Cable for E19 (RTP Only)
- "OSRK-004" PNP Inductive Sensor Repair Kit (RQC Only)
- "OSRK-005" NPN Inductive Sensor Repair Kit (RQC Only)
- "OSRK-006" Dry Contact Sensor Repair Kit (RQC Only)

PNEUMATIC ACCESSORIES

- "SLKT-402" RQC-400 Standard Seal Repair Kit
- "SLKT-403" RQC-800 Standard Seal Repair Kit
- "SLKT-404" RQC-1200 Standard Seal Repair Kit

Tool Changers and Adaptors - Automatic Tool Changers

RQC/RTP - Base Models, Optional Electrical and Air Modules



Robot Side
RQC-400

Tool Side
RTP-400

Robot Side
RQC-800

Tool Side
RTP-800

Robot Side
RQC-1200

Tool Side
RTP-1200

Base Model	Model Size	Port Options	Sensing (RQC-only)	No Modules (for Base Models)
RQC	400	N	CP	0000
"RQC" Robot Side Adaptor Module	"400" 180kg [400 lb] Max. Payload	"N" NPT Port	"LO" No Sensing	No Sensing
"RTP" Tool Side Adaptor Module	"800" 360kg [800 lb] Max. Payload	"M" BSPP Port	"LP*" PNP Inductive Sensing	PNP Inductive Sensing
	"1200" 550kg [1200 lb] Max. Payload	"A" BSPT Port	"CP†" PNP Inductive Sensing with M12 connector	PNP Inductive Sensing with M12 connector
			"LN**" NPN Inductive Sensing	NPN Inductive Sensing
			"CN†" NPN Inductive Sensing with M12 connector	NPN Inductive Sensing with M12 connector
			"LD**" Dry contact sensor	Dry contact sensor
			"CD†" Dry contact sensor with M12 connector	Dry contact sensor with M12 connector
			(*) Requires E19 module or G19 module mounted on side C.	
			(†) Cordset or plug are sold separately.	

Optional Electrical Modules



19 Pin Module, 3 Amp - 48 VDC

Module	Robot Side	Tool Side
E19	KE19-RQC	KE19-RTP



19 Pin Module, 5 Amp - 120 VDC

Module	Robot Side	Tool Side
G19	KG19-RQC	KG19-RTP

Module kits include: 90° Plug support (without cable), indexing sleeves and hardware.

Optional Air Modules with Shut Off



Double shut-off		
Module	Robot Side	Tool Side
SN	KSN-RQC800	KSN-RTP800
SP	KSP-RQC800	KSP-RTP800
ST	KST-RQC800	KST-RTP800

Single shut-off	
Module	Tool Side
RN	KRN-RTP800
RP	KRP-RTP800
RT	KRT-RTP800

Module kits above include: Couplings, indexing sleeves and hardware.

Tool Changers and Adaptors - Automatic Tool Changers
RQC/RTP - Optional Air, Vacuum and Fluid Ports Modules, Weld Gun Modules

Air Ports Modules with Face Seals

For RQC/RTP 400

Module	Robot Side	Tool Side
FN	KFN-RQC200	KFN-RTP200
FP	KFP-RQC200	KFP-RTP200
FT	KFT-RQC200	KFT-RTP200

For RQC/RTP 800 & RQC/RTP 1200

Module	Robot Side	Tool Side
FN	KFN-RQC800	KFN-RTP800
FP	KFP-RQC800	KFP-RTP800
FT	KFT-RQC800	KFT-RTP800

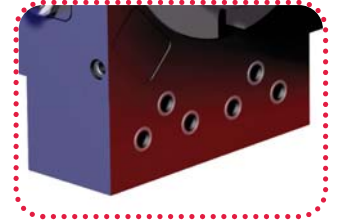

For RQC/RTP 800 & RQC/RTP 1200

Module	Robot Side	Tool Side
PN	KPN-RQC800	KPN-RTP800
PP	KPP-RQC800	KPP-RTP800
PT	KPT-RQC800	KPT-RTP800

For RQC/RTP 800 & RQC/RTP 1200

Module	Robot Side	Tool Side
AN	KAN-RQC800	KAN-RTP800
AP	KAP-RQC800	KAP-RTP800
AT	KAT-RQC800	KAT-RTP800



Module kits above include: Couplings, indexing sleeves and hardware.

Vacuum Ports Modules with Face Seal

For RQC/RTP 400

Module	Robot Side	Tool Side
VN	KVN-RQC200	KVN-RTP200
VP	KVP-RQC200	KVP-RTP200
VT	KVT-RQC200	KVT-RTP200

For RQC/RTP 800 & RQC/RTP 1200

Module	Robot Side	Tool Side
VN	KVN-RQC800	KVN-RTP800
VP	KVP-RQC800	KVP-RTP800
VT	KVT-RQC800	KVT-RTP800



Module kits above include: Couplings, indexing sleeves and hardware.

Fluid Ports Modules, Non-Spilling, Double Shut-off

For RQC/RTP 800 & RQC/RTP 1200

Module	Robot Side	Tool Side
HN	KHN-RQC800	KHN-RTP800
HP	KHP-RQC800	KHP-RTP800
HT	KHT-RQC800	KHT-RTP800



Module kits include:
Couplings, indexing sleeves and hardware.

Weld Gun Modules

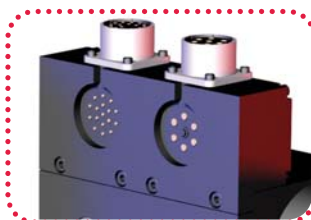

(†) The (xx) is replaced by two digits depending on wiring request. Wiring may depend on robot and welding gun specifications. Please consult factory.

(*) SRxx module can be mounted on the HI module to use with electric welding gun. Order HISR(xx).

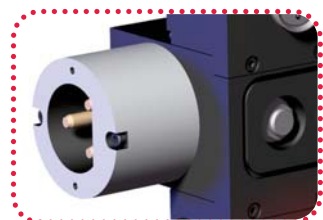

For RQC/RTP 800 & RQC/RTP 1200

Module	Robot Side	Tool Side
SR(xx) †*	KSR(xx)-RQC800 †*	KSR(xx)-RTP800 †*

Module kits include: Straight plug (without cable, crimp contacts), seals, indexing sleeves and hardware.

For RQC/RTP 800 & RQC/RTP 1200

Module	Robot Side	Tool Side
HI	KHI-RQC800	KHI-RTP800

Module kits above include: Plugs, seals, indexing sleeves and hardware.

Tool Changers and Adaptors - Automatic Tool Changers

QC/TP - Base Models

Robot Side QC-30	Tool Side TP-30	Robot Side QC-60	Tool Side TP-60	Robot Side QC-60-10P	Tool Side TP-60-10P	Robot Side QC-150	Tool Side TP-150			
Base Model		Model Size		Port Options		I/O Block		Optional Modules		10-Port (for QC/TP-60 only)
RQC		60		M		E15		PN18		10P
"QC" Robot Side Adaptor Module		"30" 13.6kg [30 lb] Max. Payload		"Blank" NPT Port		"0" No I/O Block		Optional modules below are used with QC/TP-60 and QC/TP-150 only		
"TP" Tool Side Adaptor Module		"60" 27kg [60 lb] Max. Payload		"M" BSPP Port		"E15" 15-pin, Sub-D		"E26" 26-PIN 5A Module		
		"150" 68kg [150 lb] Max. Payload		"A" BSPT Port		"D15" (2) x E15 (QC/TP-30 only)		"E19*" 19-PIN 5A Module		
						"E12" 12-pin, Turck		"E10" 10-PIN 13A Module		
								"PN18" 4 X 1/8" NPT Pneumatic Port		
								"PP18" 4 X 1/8" BSPP Pneumatic Port		
								"PT18" 4 X 1/8" BSPT Pneumatic Port		
								"PN14" 2 X 1/4" NPT Pneumatic Port		
								"PP14" 2 X 1/4" BSPP Pneumatic Port		
								"PT14" 4 X 1/4" BSPT Pneumatic Port		
								"HN38" 2 X 3/8" NPT Fluid Port		

QC/TP-30 and QC/TP-60-10P cannot be ordered with optional modules

Electric and Pneumatic Accessories (Ordered Separately)

Electrical Accessories

- "ELCT-047"** Straight Female 12-pin D-Sub User Plug, w/o Cable, Solder Type for E15 (QC/TP-60/150)
- "CABL-021"** 90° Female Cordset 4M for E12 (QC-30/60/150)
- "CABL-023"** 90° Male Cordset 2M for E12 (TP-30/60/150)
- "CABL-024"** Straight Male Cordset 1.2M for E15 (QC/TP-30)
- "OSRK-009"** NPN Inductive Sensor Repair Kit (QC-150 Only)
- "OSRK-010"** PNP Inductive Sensor Repair Kit (QC-150 Only)

Pneumatic Accessories

- "SLKT-387"** Seal Repair Kit (QC-30)
- "SLKT-388"** Face Seal Repair Kit (QC-30)
- "SLKT-389"** Seal Repair Kit (QC-60)
- "SLKT-390"** Face Seal Repair Kit (QC-60/150)
- "SLKT-392"** Face Seal Repair Kit (QC-60-10P)
- "SLKT-393"** Seal Repair Kit (QC-150)

QC/TP I/O Block



15 Pin w/Sub-D Conn and User Plug w/o cable

Model	Module	Robot Side	Tool Side
QC/TP30	E15	KE15-QC30	KE15-TP30
QC/TP60	E15	KE15-QC60	KE15-TP60
QC/TP150	E15	KE15-QC150	KE15-TP150

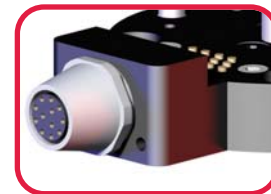

12 Pin w/Turck M12 Conn w/o Cordset

Model	Module	Robot Side	Tool Side
QC/TP30	E12	KE12-QC30	KE12-TP30
QC/TP60	E12	KE12-QC60	KE12-TP60
QC/TP150	E12	KE12-QC150	KE12-TP150

Tool Changers and Adaptors - Automatic Tool Changers E10/E19/E26 Optional Electric Modules

10-Pin Module 5Amp @ 120VDC

Model	Module	Robot Side	Tool Side	*Accessory
QC/TP60	E10	KE10-QC60	KE10-TP60	ELCT-041 (Female)
QC/TP150	E10	KE10-QC150	KE10-TP150	ELCT-042 (Male)

*Straight Plug, (w/o Cable), Solder Type, Cable Clamp

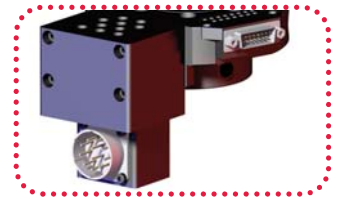

19-Pin Module 5Amp @ 120VDC

Model	Module	Robot Side	Tool Side	*Accessory
QC/TP60	E19	KE19-QC60	KE19-TP60	ELCT-043 (Female)
QC/TP150	E19	KE19-QC150	KE19-TP150	ELCT-044 (Male)

*Straight Plug, (w/o Cable), Solder Type, Cable Clamp

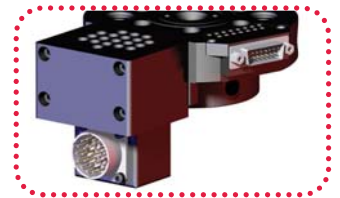

26-Pin Module 5Amp @ 120VDC

Model	Module	Robot Side	Tool Side	*Accessory
QC/TP60	E26	KE26-QC60	KE26-TP60	ELCT-045 (Female)
QC/TP150	E26	KE26-QC150	KE26-TP150	ELCT-046 (Male)

*Straight Plug, (w/o Cable), Solder Type, Cable Clamp



Module kits above include: Flat for module mounting, straight plug (without cable), locating pins and hardware.

4 X 1/8" Air Ports Module, Face Seal

For QC/TP-60

Module	Robot Side	Tool Side
PN18	KPN18-QC60	KPN18-TP60
PP18	KPP18-QC60	KPP18-TP60
PT18	KPT18-QC60	KPT18-TP60
Seal Kit	SLKT-391	---

For QC/TP-150

Module	Robot Side	Tool Side
PN18	KPN18-QC150	KPN18-TP150
PP18	KPP18-QC150	KPP18-TP150
PT18	KPT18-QC150	KPT18-TP150
Seal Kit	SLKT-391	---

Module kits include: Flat for module mounting, seals, locating pins and hardware.

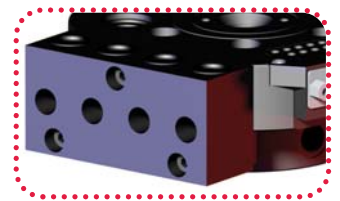

2 X 1/4" Air Ports Module, Face Seal

For QC/TP-60

Module	Robot Side	Tool Side
PN14	KPN14-QC60	KPN14-TP60
PP14	KPP14-QC60	KPP14-TP60
PT14	KPT14-QC60	KPT14-TP60
Seal Kit	SLKT-395	---

For QC/TP-150

Module	Robot Side	Tool Side
PN14	KPN14-QC150	KPN14-TP150
PP14	KPP14-QC150	KPP14-TP150
PT14	KPT14-QC150	KPT14-TP150
Seal Kit	SLKT-395	---

Module kits include: Flat for module mounting, seals, locating pins and hardware.

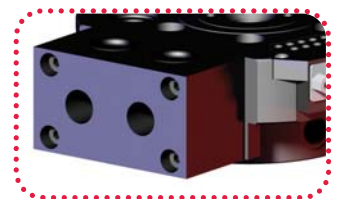

2 X 3/8" Fluid Ports Module, Non-Spilling Double Shut-off

For QC/TP-60

Module	Robot Side	Tool Side
HN38	KHN38-QC60	KHN38-TP60

For QC/TP-150

Module	Robot Side	Tool Side
HN38	KHN38-QC150	KHN38-TP150

Module kits include: Flat for module mounting couplings, locating pins and hardware.

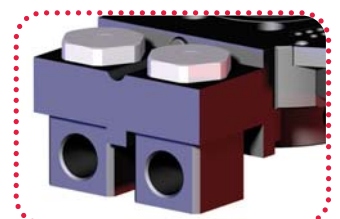

Tool Changers and Adaptors - Manual Tool Changers

RDN/RDC - Product Overview

(Handle in locking position)

RDN-10 Housing
RDC-10/25M Bayonet
for Ø25mm/1.00"(in)
Tooling Boom/Tubes

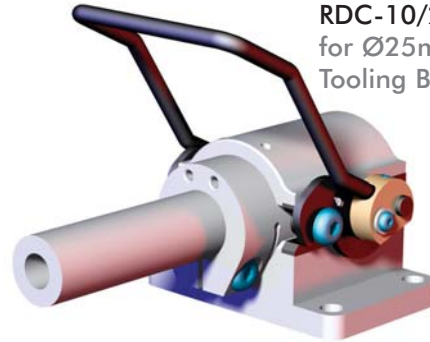

(Handle in release position)

Base and flange mounting
for RDN-10/40 Housing

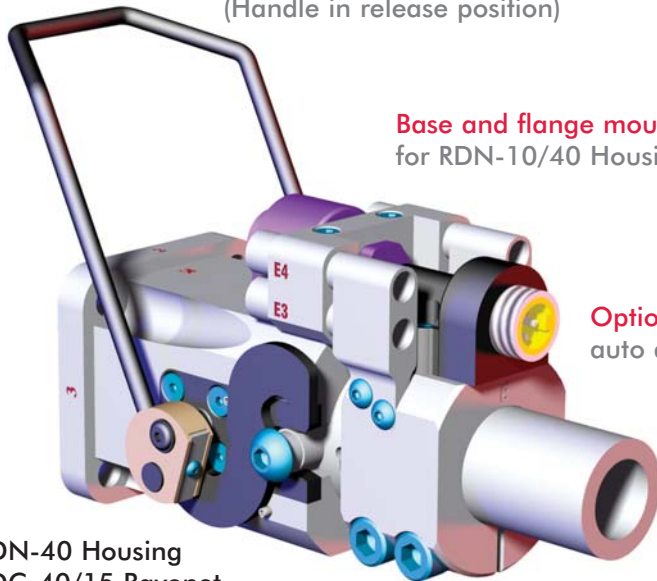

RDN-40 Housing
RDC-40/15 Bayonet
for Ø40mm/1.50"(in)
Tooling Boom/Tubes

Patented internal urethane bumpers
ensure a tight interface between the
robot and tool sides

Optional air port modules
auto disconnect when handle is released

(Handle in locking position)

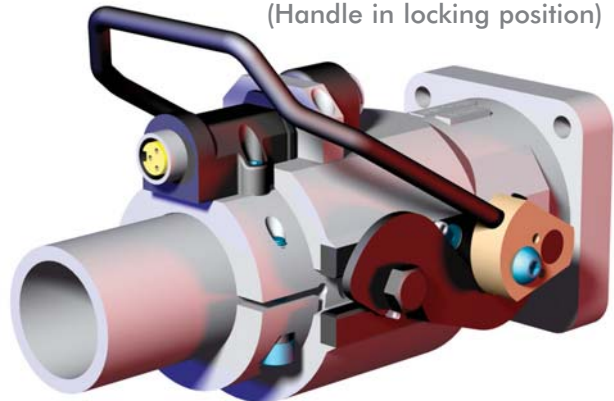

RDN-25 Housing
RDC-60/25 Bayonet
for Ø60mm/2.50"(in)
Tooling Boom/Tubes

Air & electrical connections
stay properly sequenced when tool is removed.

Additional electrical connectors available
RDN-40 and RDH electrical connectors must
be ordered separately from Housing/Bayonet.

To order RDN-25 housing with handle
in Inverted Position, add **"-INV"** to the
end of order number

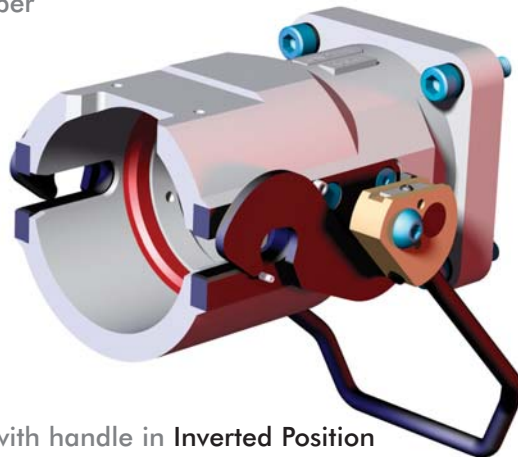

Housing with handle in Inverted Position

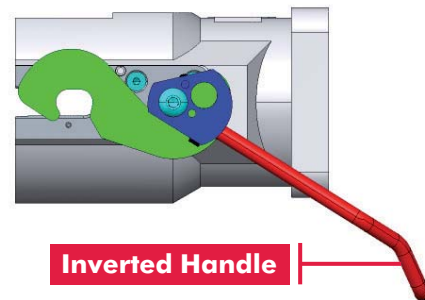

Inverted Handle

Figure 3

Tool Changers and Adaptors - Manual Tool Changers
RDN-10/RDC-10/25 - Ø1.00"/25mm Quick Disconnect Housing

	Model	Mounting	Air Port Connection	Electrical Connection
CPI	RDN-10	1F	4AS	5E
	 "RDN-10" Ø25mm/1.00" Housing	 "1F" Flange Type "1B" Base Type	 "1A" (3-Port Connector) "5A" (5-Port Connector) "4AS" (4-Port Connector) (Leave blank for No Options)	 "5E" (5-Pin Connector) (Only available for "4AS" Option)



"1F"
Flange Type

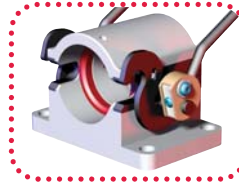

"1B"
Base Type

RDN-10 Quick Disconnect Housing Air and Electric Connection



3-Port Air Connection
RDN-10-8



5-Port Air Connection
RDN-10-9



4-Port Air Connection
with Shut-off
RDN-10-4AS



5-Pin Micro Electric
Connection
CPI-RDH-F5S-5MCM

RDC-10 Quick Disconnect Bayonet

	Model	Boom/Tube (Ø) "D"	Air Port Connection	Electrical Connection
CPI	RDC	10	4AS	5E
	 "RDC" Quick Disconnect Bayonet	 "10" 1.00"(in) "25M" 25mm	 "1" No Options "1A" (3-Port Connector) "5A" (5-Port Connector) "4AS" (4-Port Connector)	 "5E" (5-Pin Connector) (Only available for "4AS" Option)

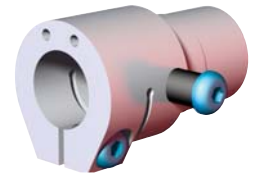

RDN-10 Quick Disconnect Air and Electric Connection



3-Port Air Connection
RDC-10-3



5-Port Air Connection
RDC-10-5

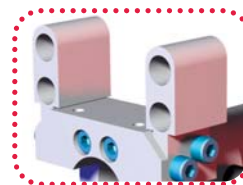

4-Port Air Connection
with Shut-off
RDC-10-4
(2) Required



5-Pin Micro Electric
Connection
CPI-RDB-M5P-5MCF

Tool Changers and Adaptors - Manual Tool Changers

RDN-40 - Ø1.50"/40mm Quick Disconnect Housing

CPI	Model	Mounting	Air Port Connection		Key Position	Electrical Connection	
	RDN-40	1F	S4		K2	MCE	HF
	"RDN-40" Ø40mm/1.50" Housing	"1F" Flange Type "1B" Base Type	"S4" (4-Port Internal) "E4" (4-Port External) "E6" (6-Port External) "SE4" (4-Port Int & Ext) (Leave blank for No Options)		"K1" "K2" "K3" "K4" (Leave blank for No Options)	"MC" (Micro 5-Pin) "MN" (Mini 3-Pin) (Leave blank for No Options) Add HF for "E4" Air Port Connection Only	

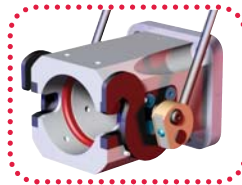

"1F" Flange Type



"1B" Base Type

RDN-40-1F Flange Type Mounting Internal Air and Locating Key

Key Location: Match "K" Mark to number mark as shown below



4-Port Internal Air Connection
RDN-40-10-1AB
Air fittings (4) Needed
RDN-AS-U18



Locating Key
RDN-40-10-1KB
1AB & 1KB options
Each requires (1)
M6 x 25mm Dowel

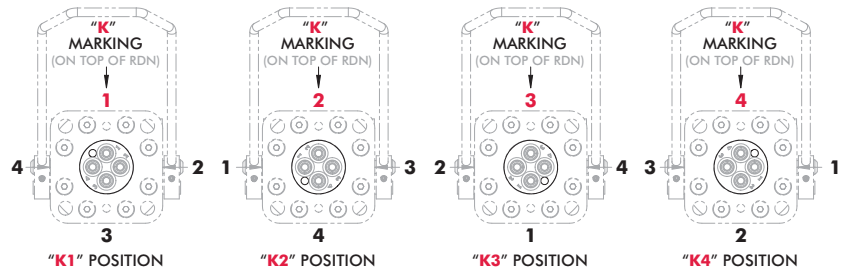

RDN-40-1B Base Type Mounting Internal Air and Locating Key

Key Location: Match "K" Mark to number mark as shown below



4-Port Internal Air Connection
RDN-40-10-1AB
Air fittings (4) Needed
RDN-SAS-U18



Locating Key
RDN-40-10-1KB
Base Mount Ring
(1) Required
RDN-40-3-MR

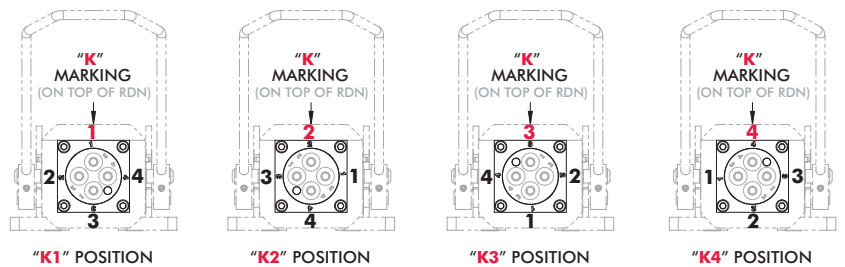

RDN-40 Base Type External Air and Electric Connection

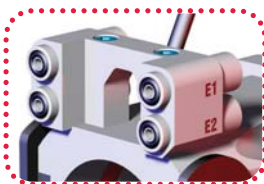

Standard 4-Port Air Connection "E4"
4xCPI-RDN-40-4AS
4-Port Air Connection with
HF = High Flow OPTION
4xCPI-RDN-40-4AS-HF

Air fittings
RDN-AS-U18
Qty needed
dependant on
of Ports



6-Port Air Connection
RDN-40-10-6PA



5-Pin Micro Electric
Connection
CPI-RDH-F5S-5MCM



3-Pin Mini Electric
Connection
CPI-TTH-F3S-3B3

Tool Changers and Adaptors - Manual Tool Changers
RDC-15/40 - Ø1.50"/40mm Quick Disconnect Bayonet

CPI	RDC	40	S4	K1	MC	HF
	"RDC" Bayonet	"15" 1.50"(in) "40" 40mm Add "-1" after Boom/Tube (Ø) for No Options	"S4" (4-Port Internal) "E4" (4-Port External) "E6" (6-Port External) "SE4" (4-Port Int & Ext) (Leave blank for No Options)	"K1" "K2" "K3" "K4" (Leave blank for No Options)	"MC" (Micro 5-Pin) "MN" (Mini 3-Pin) (Leave blank for No Options)	Add HF for "E4" Air Port Connection Only

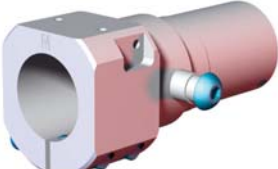

RDC-15/40 Internal Air Connection and Locating Key

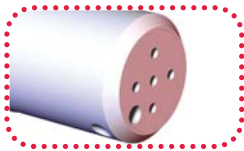

4-Port Internal
Air Connection
RDC-40-4-1AB

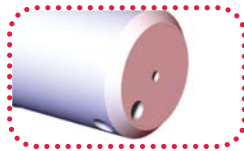

Locating Key
RDC-40-4-1KB

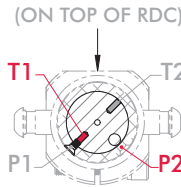

"K1" POSITION
FASTENER IN
(P1/T1)

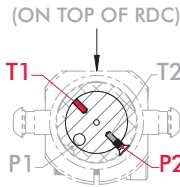

"K2" POSITION
FASTENER IN
(P2/T2)

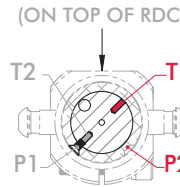

"K3" POSITION
FASTENER IN
(P1/T2)

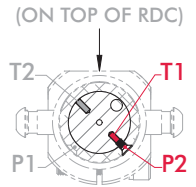

"K4" POSITION
FASTENER IN
(P2/T1)



RDC-15/40 External Air and Electric Connection

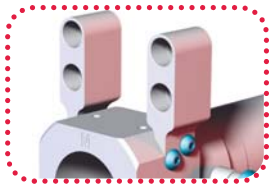

4-Port Air Connection
Standard
2xCPI-RDC-40-4

4-Port Air Connection with
HF = High Flow OPTION
CPI-RDC-40-4-HF
(2) Required



6-Port Air Connection
RDC-40-4-6PA





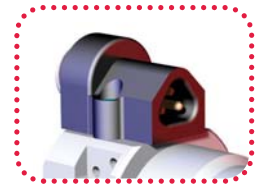

5-Pin Micro Electric
Connection
CPI-RDB-M5P-5MCF



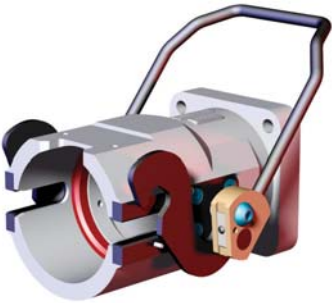

3-Pin Mini Electric
Connection
CPI-TTB-M3P-3B3

Tool Changers and Adaptors - Manual Tool Changers

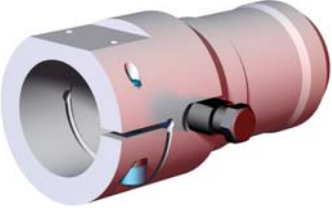

RDN/RDC - Ø2.50"/60mm Quick Disconnect Housing/Bayonets

Model	Air Port Connection	Electrical Mounting
CPI — RDN-25-6 — "RDN-25-6" Ø60mm/2.50" Housing 	A3-O1-S2 "A3-O0-S3" (0)Open-(3)Shutoff "A3-O1-S2" (1)Open-(2)Shutoff "A3-O2-S1" (2)Open-(1)Shutoff "A3-O3-S0" (3)Open-(0)Shutoff "A6-O0-S6" (0)Open-(6)Shutoff "A6-O1-S5" (1)Open-(5)Shutoff "A6-O2-S4" (2)Open-(4)Shutoff "A6-O3-S3" (3)Open-(3)Shutoff "A6-O4-S2" (4)Open-(2)Shutoff "A6-O5-S1" (5)Open-(1)Shutoff "A6-O6-S0" (6)Open-(0)Shutoff	EL10 Mounting for Large Connectors (Leave blank for Standard Mounting) 
	 "A3"	 "A6"

"RDC-xx-2" Ø2.50"/60mm Quick Disconnect Bayonet

Model	Boom/Tube (Ø) "D"	Version	Air Port Connection	Electrical Mounting
CPI — RDC — "RDC" Ø60mm/2.50" Bayonet 	25 "25" 2.50"(in) "60" 60mm	2 "2" Version 2	A3 "A3" 3-Port "A6" 6-Port	EL10 Mounting for Large Connectors (Leave blank for Standard Mounting) 

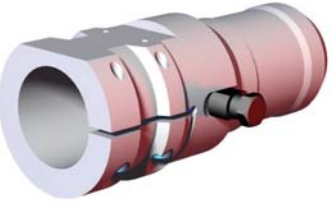
"RDC-xx-2-2HT" Ø2.50"/60mm Quick Disconnect Hi-Torque Bayonet

Model	Boom/Tube (Ø) "D"	Version	Air Port Connection	Electrical Mounting
CPI — RDC — "RDC" Ø60mm/2.50" Hi-Torque Bayonet 	25 "25" 2.50"(in) "60" 60mm	2HT "2HT" Version 2 Hi-Torque	A3 "A3" 3-Port "A6" 6-Port	EL10 Mounting for Large Connectors (Leave blank for Standard Mounting) 

RDC Bayonet 3 and 6-Port Air Connections

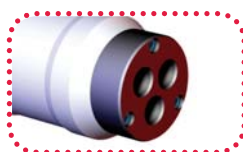

3-Port Air Connection
CPI-BC-250-3-U38



6-Port Air Connection
CPI-BC-250-6-U18

Tool Changers and Adaptors - Manual Tool Changers
 Electric Connectors for RDN/RDC Quick Disconnect Housing/Bayonets

RDH (Housing) 5-Pin Electric Connection

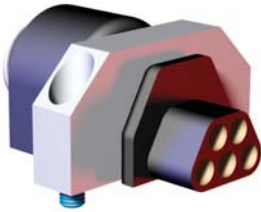

3-Pin to 5-Pin Housing
 Electric Connection
CPI-RDH-F5S-3B3

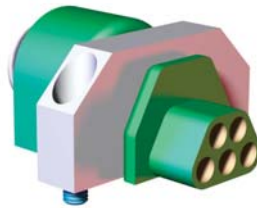

4-Pin to 5-Pin Housing
 Electric Connection
CPI-RDH-F5S-4B4



5-Pin to 5-Pin Housing
 Electric Connection
CPI-RDH-F5S-4B4

RDB (Tool Side) 5-Pin Electric Connection

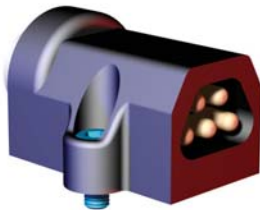

3-Pin to 5-Pin Tool Side
 Electric Connection
CPI-RDB-M5P-3B3



4-Pin to 5-Pin Tool Side
 Electric Connection
CPI-RDB-M5P-4B4



5-Pin to 5-Pin Tool Side
 Electric Connection
CPI-RDB-M5P-5B5

RDH/RDB 10-Pin (for EL10) Electric Connection

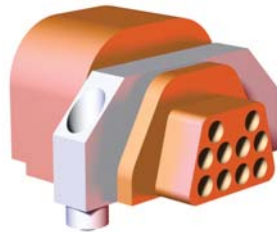

10-Pin to 10-Pin Housing
 Electric Connection
CPI-RDH-F10S-A10



10-Pin to 10-Pin Tool Side
 Electric Connection
CPI-RDB-M10P-A10

RDH/RDB 19-Pin (for EL10) Electric Connection

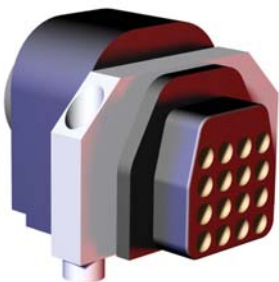

16-Pin to 19-Pin Housing
 Electric Connection
CPI-RDH-F16S-A19

19-Pin to 19-Pin Housing
 Electric Connection
CPI-RDH-F19S-A19



16-Pin to 19-Pin Tool Side
 Electric Connection
CPI-RDB-M16P-A19

19-Pin to 19-Pin Tool Side
 Electric Connection
CPI-RDB-M19P-A19

Tool Changers and Adaptors - Automation Adaptors

Ø2.50" Series Robot Adaptors - Selection Guide

250 Series Robot Adaptor Selection Guide

Adaptor Mounts		Mounting Pattern			Dowels			Pilot		Dwg Page
STYLE (Model)	Type Avail.	BOLT CIRCLE	BOLT SIZE	BOLTS QTY	BOLT CIRCLE	DWL SIZE	DWL QTY	DIAMETER (Ø)	DEPTH	
STYLE 1 (ACMX58)	DM/90	Ø90mm [Ø3.54"]	M8	8	Ø80mm [Ø3.15"]	10mm	4	N/A	N/A	50
STYLE 2 (FA500)	DM/90	Ø90mm [Ø3.54"]	M10	8	Ø90mm [Ø3.54"]	10mm	4	Ø59.5mm [Ø2.34"]	4.8 [.19]	51
STYLE 3 (KW150)	DM/90	Ø92mm [Ø3.62"]	M10	6	Ø92mm [Ø3.62"]	9mm	2	Ø54mm [Ø2.13"]	6.4 [.25]	52
STYLE 4 (FA900)	DM/90	Ø125mm [Ø4.92"]	M10	6	Ø125mm [Ø4.92"]	10mm	2	Ø79.5mm [Ø3.13"]	6.4 [.25]	53
STYLE 5 (KA760)	DM/90	Ø160mm [Ø6.30"]	M10	6	Ø160mm [Ø6.30"]	10mm	2	Ø99.9mm [Ø3.94"]	6.4 [.25]	54
STYLE 6 (MMNY300)	DM	Ø200mm [Ø7.87"]	M12	6	Ø200mm [Ø7.87"]	12mm	1	N/A	N/A	55
STYLE 7 (FA430I)	DM/90	Ø125mm [Ø4.92"]	M10	6	Ø125mm [Ø4.92"]	10mm	2	Ø79.5mm [Ø3.13"]	6.4 [.25]	56
STYLE 8 (FA420)	DM	Ø92mm [Ø3.62"]	M10	8	Ø92mm [Ø3.62"]	10mm	4	Ø79.5mm [Ø3.13"]	4.8 [.19]	57
STYLE 9 (ABB44)	DM/90	Ø100mm [Ø3.94"]	M10	6	Ø100mm [Ø3.94"]	8mm	2	Ø61.9mm [Ø2.44"]	6.4 [.25]	58
STYLE 10 (KWZ165)	DM/90	Ø125mm [Ø4.92"]	M10	10	Ø125mm [Ø4.92"]	10mm	2	Ø79.5mm [Ø3.13"]	6.4 [.25]	59
STYLE 11 (KWUT120)	90	Ø120mm [Ø4.72"]	M8	8	Ø120mm [Ø4.92"]	8mm	2	N/A	N/A	60
STYLE 12 (FA710)	DM	Ø100mm [Ø3.94"]	M8	6	Ø100mm [Ø3.94"]	8mm	2	N/A	N/A	61
STYLE 14 (MMK100)	90	Ø125mm [Ø4.92"]	M10	6	Ø125mm [Ø4.92"]	10mm	2	Ø61mm [Ø2.40"]	6.4 [.25]	62
STYLE 15 (KA660)	DM/90	Ø160mm [Ø6.30"]	M12	6	Ø160mm [Ø6.30"]	12mm	1	Ø99mm [Ø3.90"]	6.4 [.25]	63
STYLE 16 (FA2000)	DM	Ø125mm [Ø4.92"]	M10	10	Ø125mm [Ø4.92"]	10mm	2	Ø79.5mm [Ø3.13"]	6.4 [.25]	64
STYLE 18 (MMHP165)	DM/90	Ø125mm [Ø4.92"]	M10	6	Ø125mm [Ø4.92"]	10mm	2	Ø62.5mm [Ø2.46"]	6.4 [.25]	65
STYLE 19 (MMHP165)	90	Ø92mm [Ø3.62"]	M10	6	Ø125mm [Ø4.92"]	9mm	2	Ø62.5mm [Ø2.46"]	6.4 [.25]	66
STYLE 21 (EOAMC30)	DM	Ø127mm [Ø5.00"]	3/8-16	6	Ø108mm [Ø4.25"]	.25"(in)	2	N/A	N/A	67
STYLE 22 (FA900-SSM)	DM	Ø125mm [Ø4.92"]	M10	6	Ø125mm [Ø4.92"]	10mm	2	Ø79.5mm [Ø3.13"]	4.8 [.19]	68
STYLE 23 (MD350)	DM/90	Ø187.3mm [Ø7.38"]	3/8-16	4	Ø187.3mm [Ø7.38"]	3/8	2	N/A	N/A	69
STYLE 24 (SA000)	DM	Ø69.5mm [Ø2.74"]	M10	4	N/A	N/A	N/A	N/A	N/A	70

Tool Changers and Adaptors - Automation Adaptors
 Ø2.50" Series Robot Adaptors - Direct Mounts and 90° Adaptors

Robot Models Supported
ACMA X58



Style 01 - **ACMX58** (Ø90mm Bolt Circle/Ø80mm Dowel Circle)
 Direct Mount Adaptor
CPI-ACMX58-DM-RD25-(X)

Direct Mount Porting		
(X)	Porting	# of Ports
A3	3/8 NPT	3 (2/1)
A6	1/8 NPT	6 (3/3)

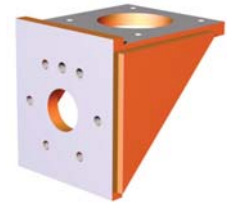

90° Adaptor
CPI-ACMX58-90-RD25-A36

Style 02 - **FA500** (Ø90mm Bolt Circle)

Robot Models Supported
FANUC
 M-400, M-500
 S-420*
 (*With FANUC Flange)

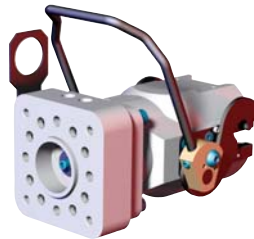

Direct Mount Adaptor
CPI-FA500-DM-RD25-(X)

Direct Mount Porting		
(X)	Porting	# of Ports
A3	3/8 NPT	3 (2/1)
A6	1/8 NPT	6 (3/3)



90° Adaptor
CPI-FA500-90-RD25-A36

Style 03 - **KW150** (Ø92mm Bolt Circle)

Robot Models Supported
KAWASAKI
 UX100, UX120
 UX150



Direct Mount Adaptor
CPI-KW150-DM-RD25-(X)

Direct Mount Porting		
(X)	Porting	# of Ports
A3	3/8 NPT	3 (2/1)
A6	1/8 NPT	6 (3/3)

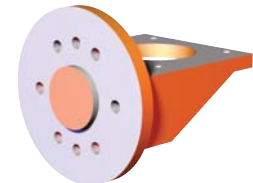

90° Adaptor
CPI-KW150-90-RD25-A36

Style 04 - **FA900** (Ø125mm Bolt Circle)

Robot Models Supported
ABB IRB
 60(00), 64(00)
FANUC
 R-2000I(6-BOLT)
 M-410, S-900
MOTOMAN
 SP100X

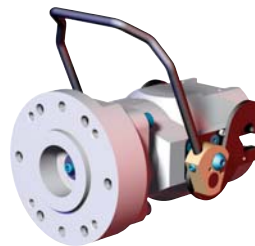

Direct Mount Adaptor
CPI-FA900-DM-RD25-(X)

Direct Mount Porting		
(X)	Porting	# of Ports
A3	3/8 NPT	3 (2/1)
A6	1/8 NPT	6 (3/3)



90° Adaptor
CPI-FA900-90-RD25-A36

Style 05 - **KA760** (Ø160mm Bolt Circle)

Robot Models Supported
KUKA
 IW 125, PL 150,
 IW 150, PL 125
 KR 125, ZH 125,
 IR 760, ZH 150

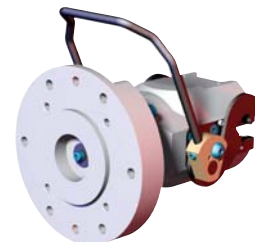

Direct Mount Adaptor
CPI-KA760-DM-RD25-(X)

Direct Mount Porting		
(X)	Porting	# of Ports
A3	3/8 NPT	3 (2/1)
A6	1/8 NPT	6 (3/3)

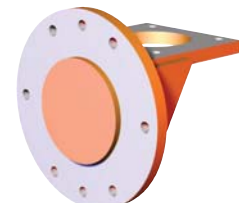

90° Adaptor
CPI-KA760-90-RD25-A36

Tool Changers and Adaptors - Automation Adaptors

Ø2.50" Series Robot Adaptors - Direct Mounts and 90° Adaptors

Style 06 - **MMNY300** (Ø200mm Bolt Circle)

Robot Models Supported
MOTOMAN
 SP100X
KUKA
 KR 350

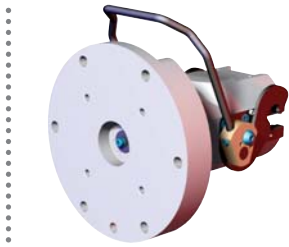

Direct Mount Adaptor
CPI-MMNY300-DM-RD25-(X)

Direct Mount Porting		
(X)	Porting	# of Ports
A3	3/8 NPT	3 (2/1)
A6	1/8 NPT	6 (3/3)

Style 07 - **FA430I** (Ø125mm Bolt Circle)

Robot Models Supported
FANUC S430I



Direct Mount Adaptor
CPI-FA430I-DM-RD25-(X)

Direct Mount Porting		
(X)	Porting	# of Ports
A3	3/8 NPT	3 (2/1)
A6	1/8 NPT	6 (3/3)

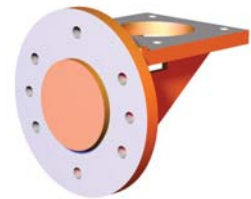

90° Adaptor
CPI-FA430I-90-RD25-A36

Style 08 - **FA420** (Ø92mm Bolt Circle)

Robot Models Supported
FANUC S420
 (WITH SPECIAL FLANGE)

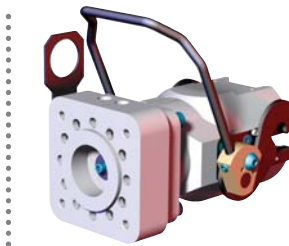

Direct Mount Adaptor
CPI-FA420-DM-RD25-(X)-SPC

Direct Mount Porting		
(X)	Porting	# of Ports
A3	3/8 NPT	3 (2/1)
A6	1/8 NPT	6 (3/3)

Style 09 - **ABB44** (Ø100mm Bolt Circle)

Robot Models Supported
ABB IRB
 4400/S, 4400/60
 4400/45,
 4400/L30



Direct Mount Adaptor
CPI-ABB44-DM-RD25-(X)

Direct Mount Porting		
(X)	Porting	# of Ports
A3	3/8 NPT	3 (2/1)
A6	1/8 NPT	6 (3/3)

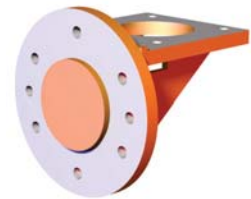

90° Adaptor
CPI-ABB44-90-RD25-A36

Style 10 - **KWZ165** (Ø125mm Bolt Circle)

Robot Models Supported
KAWASAKI Z165



Direct Mount Adaptor
CPI-KWZ165-DM-RD25-(X)

Direct Mount Porting		
(X)	Porting	# of Ports
A3	3/8 NPT	3 (2/1)
A6	1/8 NPT	6 (3/3)

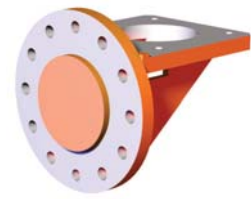

90° Adaptor
CPI-FKWZ165-90-RD25-A36

Tool Changers and Adaptors - Automation Adaptors
 Ø2.50" Series Robot Adaptors - Direct Mounts and 90° Adaptors

Style 11 - KWUT120-90
 (Ø120mm Bolt Circle)



90° Adaptor
 CPI-KWUT120-90-RD25-A36

Robot Models Supported
KAWASAKI UT120

Style 12 - FA710-DM
 (Ø100mm Bolt Circle)



Direct Mount Adaptor
 CPI-FA710-DM-RD25-A6

Robot Models Supported
FANUC M710

Style 14 - MMK100-90
 (Ø125mm Bolt Circle)

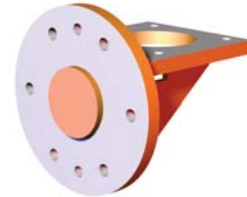

90° Adaptor
 CPI-MMK100-90-RD25-A36

Robot Models Supported
COMAU CMH3.2
MOTOMAN K100, UP130

Style 15 - KA660 (Ø160mm Bolt Circle)

Robot Models Supported
KUKA 660

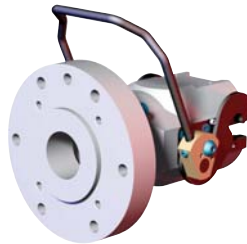

Direct Mount Adaptor
 CPI-KA660-DM-RD25-00



90° Adaptor
 CPI-KA660-90-RD25-A36

Style 16 - FA2000 (Ø125mm Bolt Circle)

Robot Models Supported
FANUC R2000i

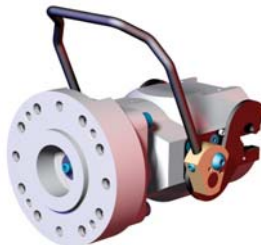

Direct Mount Adaptor
 CPI-FA2000-DM-RD25-(X)

Direct Mount Porting		
(X)	Porting	# of Ports
A3	3/8 NPT	3 (2/1)
A6	1/8 NPT	6 (3/3)



90° Adaptor
 CPI-FA2000-90-RD25-A36

Style 18 - MMHP165 (Ø125mm Bolt Circle)

Robot Models Supported
MOTOMAN ES165N
HP165



Direct Mount Adaptor
 CPI-MMHP165-125-RD25-(X)

Direct Mount Porting		
(X)	Porting	# of Ports
A3	3/8 NPT	3 (2/1)
A6	1/8 NPT	6 (3/3)

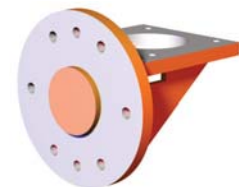

90° Adaptor
 CPI-MMHP165-125-90-RD25-A36

Tool Changers and Adaptors - Automation Adaptors

Ø2.50" Series Robot Adaptors - Direct Mounts and 90° Adaptors

Style 19 - **MMHP165-92-90**
(Ø92mm Bolt Circle)

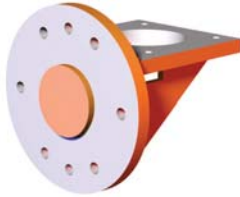

90° Adaptor

CPI-**MMHP165-92-90-RD25-A36**

Robot Models Supported

HP165, ES165N

Style 21 - **EOAMC30**
(Ø127mm Bolt Circle/
Ø108mm Dowel Circle)

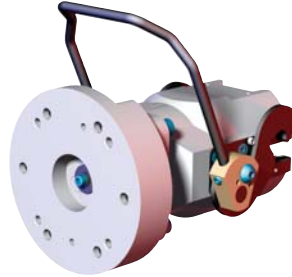

Direct Mount Adaptor

CPI-**EOAMC30-DM-RD25-A6**

Style 22 - **FA900-SSM**
(Ø125mm Bolt Circle)

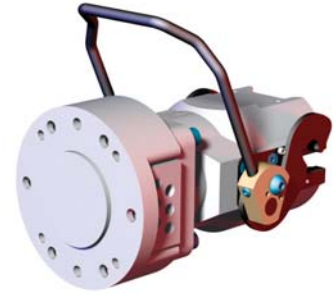

Direct Mount Adaptor

CPI-**FA900-SSM-RD25-A6**

Style 23 - **MD350** (Ø187mm Bolt Circle)

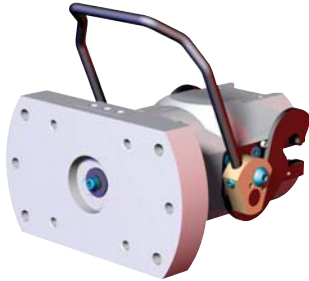

Direct Mount Adaptor

CPI-**EOAMC30-DM-RD25-A6**

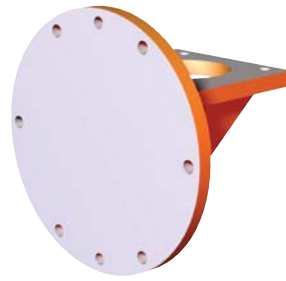

90° Adaptor

CPI-**MD350-90-RD25-A36**

Style 24 - **SA000** (Ø69.5mm Bolt Circle)



Direct Mount Adaptor

CPI-**SA000-DM-RD25-A6**

CM675XL (Ø76mm Bolt Circle)



Direct Mount Adaptor

CPI-**CM675XL-DM-RD25-A3**

CHM32 (Ø125mm Bolt Circle)

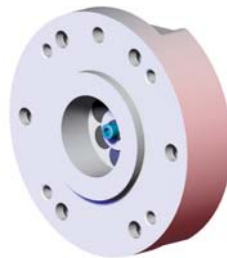

Direct Mount Adaptor
CPI-**CHM32-DM-RD25-(X)**

Direct Mount Porting

(X)	Porting	# of Ports
A3	3/8 NPT	3 (2/1)
A6	1/8 NPT	6 (3/3)

FA710 (Ø100mm Bolt Circle)

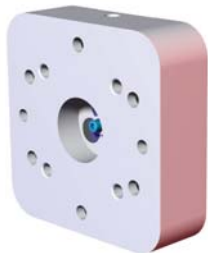

Direct Mount Adaptor

CPI-**FA710-DM-TT15-A3**

FA710IC (Ø100mm Bolt Circle)



90° Adaptor

CPI-**FA710IC-90-RD40-A3**

KWFS45N-90 (Ø100mm Bolt Circle)

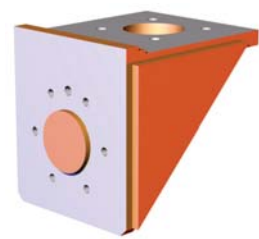

90° Adaptor

CPI-**KWFS45N-90-TTN40-A3**

Tool Changers and Adaptors - Automation Adaptors
Direct Mount Adaptors Plates and ATI Adaptors

TDA-150F Adaptor Plate



(Ø85mm Bolt Circle)
CPI-TDA-150F-312F

TDA-250F Adaptor Plate



(Ø125mm Bolt Circle)
CPI-TDA-250F-312F

FA900 Adaptor Plate

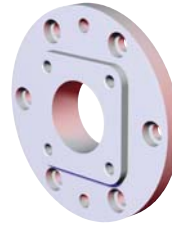

(Ø125mm Bolt Circle)
CPI-FA900-DM-238F

KW150 Adaptor Plate



(Ø92mm Bolt Circle)
CPI-KW150-25-312F

CL-LAN Adaptor Plate



(Ø125mm Bolt Circle)
CPI-CL-LAN-EOL

ATI-151 90° Medium Duty

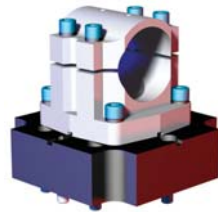

(Ø125mm Bolt Circle)
CPI-ATI-151-90-WT

ATI-90 Light Duty

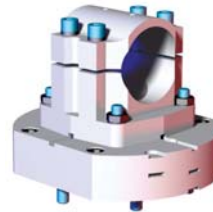

(Ø125mm Bolt Circle)
CPI-ATI-90

ATI-90-SP 90° Light Duty

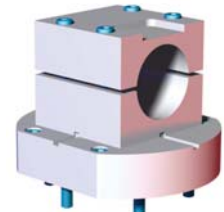

(Ø125mm Bolt Circle)
CPI-ATI-90-SP

ATI-201 - Ø60mm



(Ø125mm Bolt Circle)
CPI-ATI-201-60

ATI-201-90 Ø2.50"



(Ø125mm Bolt Circle)
CPI-ATI-201-90-HD

ATI-201-90 Ø3.50"

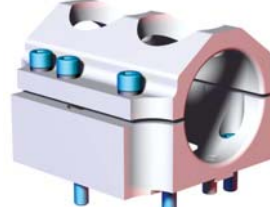

(Ø125mm Bolt Circle)
CPI-ATI-201-90-3HD

ATI 90° World Tool Ø2.50"

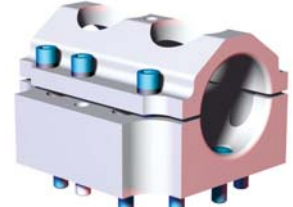

(Ø125mm Bolt Circle)
CPI-ATI-201-250-10S

ATI-201 90°

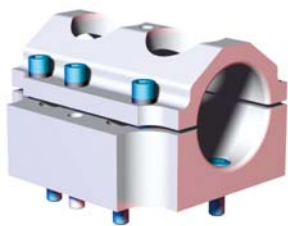

(Ø125mm Bolt Circle)
CPI-ATI-201-(X)-90

ATI-201 90°	
(X)	Tube (Ø)
60	Ø60mm
250	Ø2.50"(in)

NAV Assembly and Block

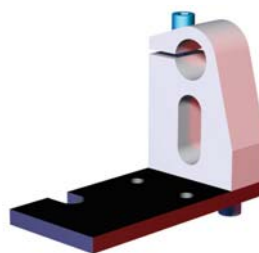

CPI-NAV-(X)-CM

NAV Series	
(X)	Tube (Ø)
25	Ø25mm
100	Ø1.00"(in)



CPI-NAV-(X)-BL

Tool Changers and Adaptors - Automation Adaptors

RAV Doppin Adaptor - Single Housing Mounting with Air Access

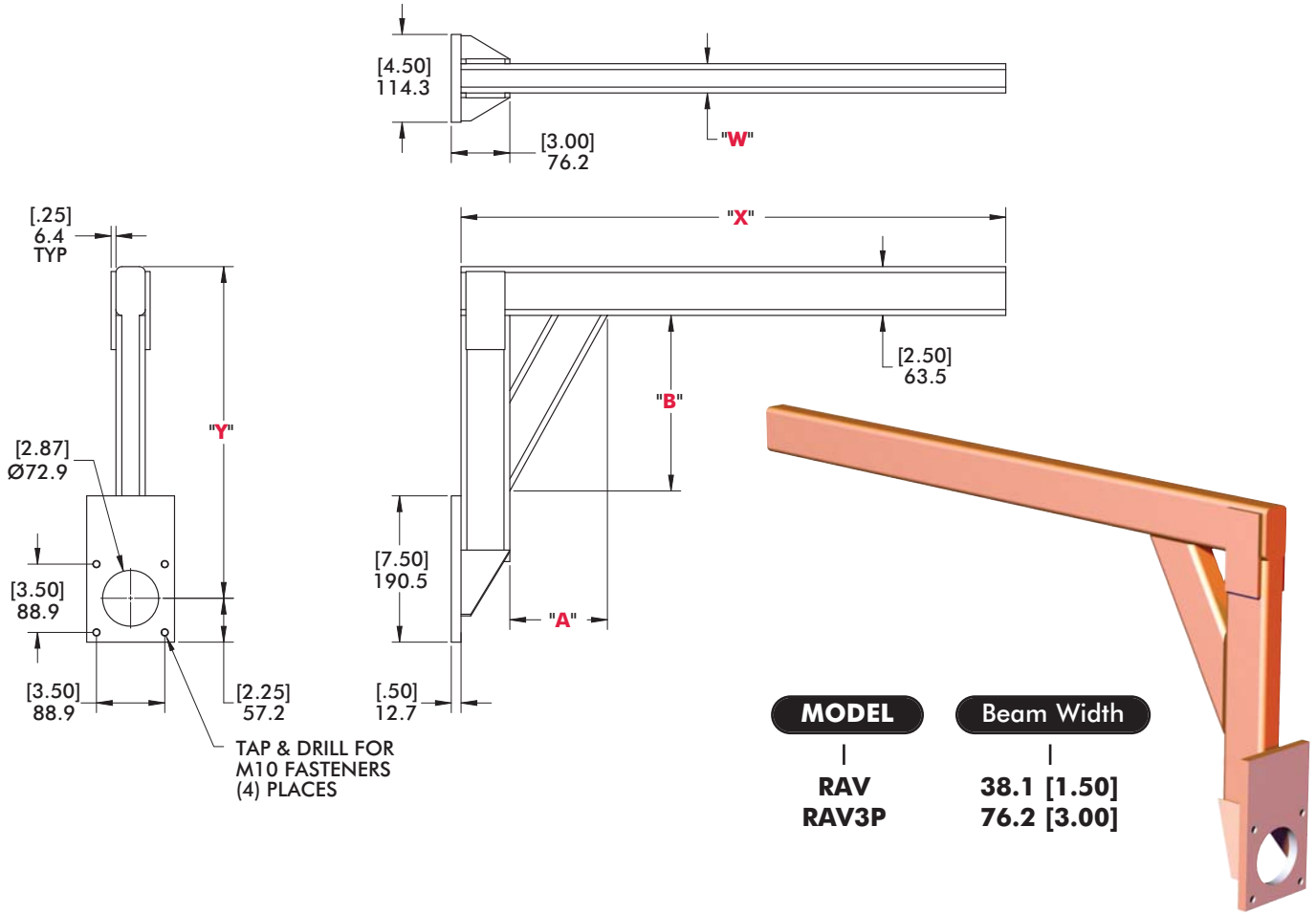

CPI	MODEL	A	"X"	"Y"	"A"	"B"
	RAV		24	8-16	0 ("Y"=8-16)	0 ("Y"=8-16)
	RAV3P		36			
			42 (RAV3P)	17-24	4-19 ("X"=24)	9 ("Y"=17-18)
			48		4-31 ("X"=36)	10 ("Y"=19-20)
			60		4-36 ("X"=42/48/60)	11 ("Y"=21-22)
						12 ("Y"=23-24)

RAV Doppin Adaptor - Double Housing Mounting with Air Access

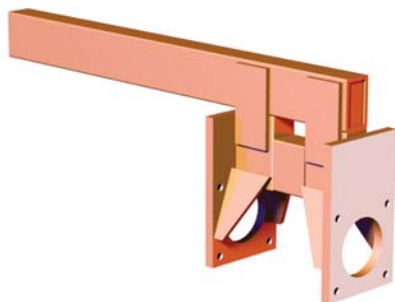

Double Housing Mount
with Air Access

Model
CPI-RAV-A-DH8-24-8

Tool Changers and Adaptors - Automation Adaptors Nest Stand Assemblies

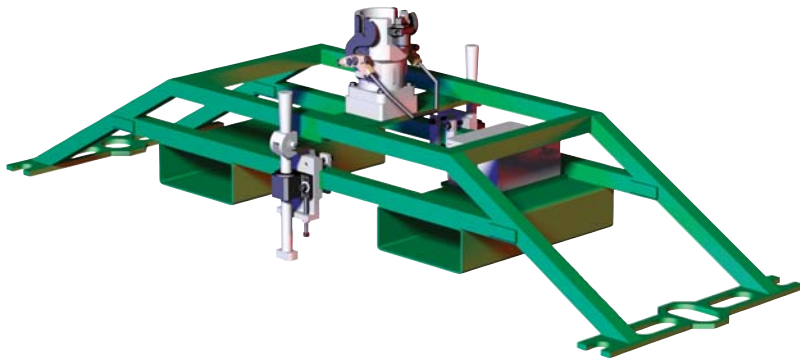

Press Nest Stand

Model

CPI-PNS-ASSY

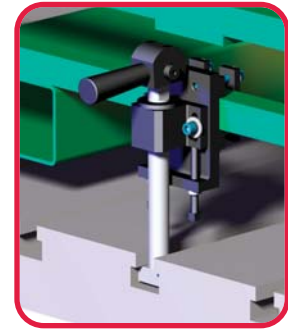

BLC Bolster Locking Clamp

Model

CPI-BLC-100-15-6

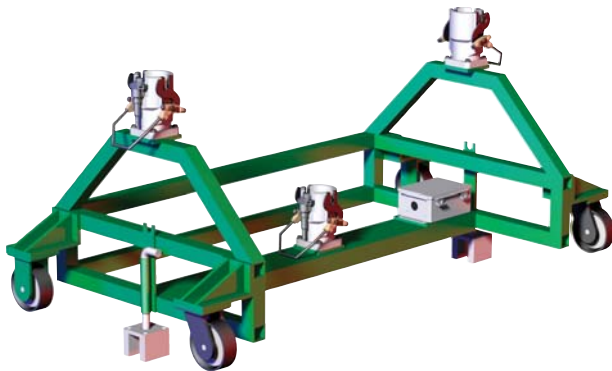

Idle Nest Stand

Model

CPI-INS-ASSY

